



Model Number

OBT30-R2F-E0

Triangulation sensor (BGS)
with 2 m fixed cable

Features

- Very flat design for direct mounting without mounting bracket
- Precision object detection, almost irrespective of the color
- Small parts detection from 0.1 mm
- Highly visible light spot, even on dark materials
- High degree of immunity to extraneous light

Dimensions

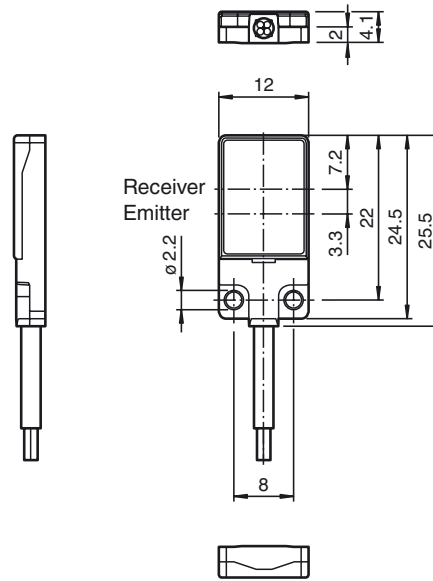

Electrical connection

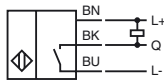

Release date: 2019-10-30 03:46 Date of issue: 2019-10-30 253569_eng.xml

Refer to "General Notes Relating to Pepperl+Fuchs Product Information".

Technical data**General specifications**

Detection range	1 ... 30 mm
Reference target	standard white, 100 mm x 100 mm
Light source	LED
Light type	modulated visible red light , 630 nm
LED risk group labelling	exempt group
Black/White difference (6 %/90 %)	< 20 % at 30 mm
Angle deviation	approx. 2 °
Object size	typ. starts from 0.1 mm @ 16 mm
Diameter of the light spot	approx. 5.5 mm at a distance of 30 mm
Angle of divergence	approx. 5 °
Optical face	frontal
Ambient light limit	EN 60947-5-2 : 25000 Lux

Functional safety related parameters

MTTF _d	800 a
Mission Time (T _M)	20 a
Diagnostic Coverage (DC)	0 %

Indicators/operating means

Operation indicator	LED green, statically lit Power on , short-circuit : LED green flashing (approx. 4 Hz)
Function indicator	LED yellow ON: lights when object is detected

Electrical specifications

Operating voltage	U _B	10 ... 30 V DC
No-load supply current	I ₀	< 15 mA
Protection class		III

Output

Switching type	NO contact / light on	
Signal output	1 NPN output, short-circuit protected, reverse polarity protected, open collector	
Switching voltage	max. 30 V DC	
Switching current	max. 50 mA , resistive load	
Voltage drop	U _d	≤ 1.5 V DC
Switching frequency	f	approx. 1 kHz
Response time		500 μs

Conformity

Product standard	EN 60947-5-2
------------------	--------------

Ambient conditions

Ambient temperature	-20 ... 60 °C (-4 ... 140 °F)
Storage temperature	-20 ... 70 °C (-4 ... 158 °F)

Mechanical specifications

Housing width	12 mm
Housing height	25.5 mm
Housing depth	4.1 mm
Degree of protection	IP67
Connection	2 m fixed cable
Material	
Housing	PC (Polycarbonate) and Stainless steel
Optical face	PMMA
Cable	PUR
Mass	approx. 20 g
Tightening torque, fastening screws	0.25 Nm
Cable length	2 m

Approvals and certificates

UL approval	E87056 , cULus Recognized, Class 2 Power Source
CCC approval	CCC approval / marking not required for products rated ≤36 V

Other suitable accessories can be found at
www.pepperl-fuchs.com

Curves/Diagrams

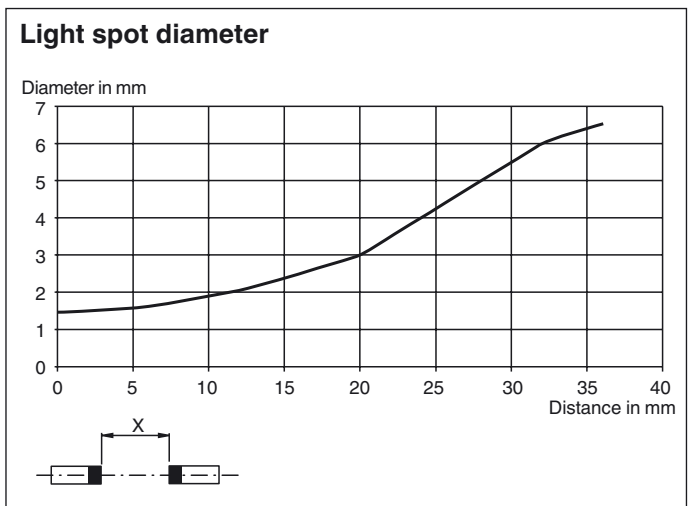
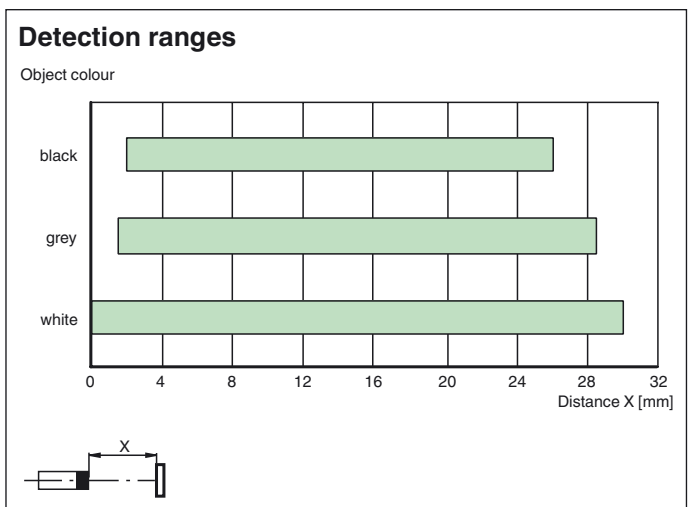
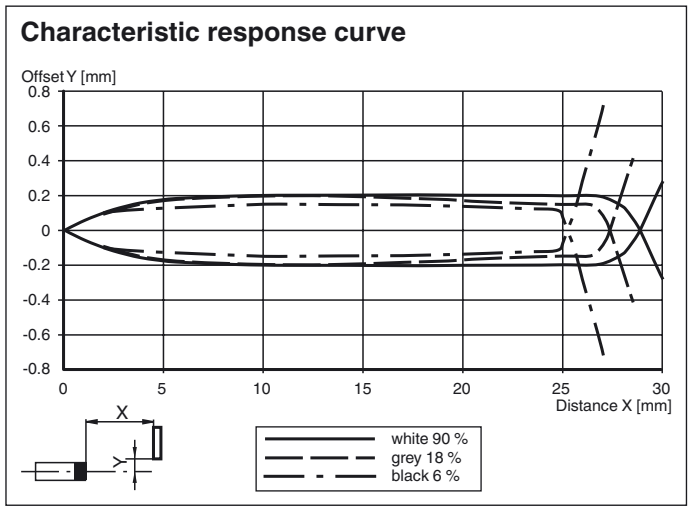

Release date: 2019-10-30 03:46 Date of issue: 2019-10-30 253569_eng.xml

Refer to "General Notes Relating to Pepperl+Fuchs Product Information".